

WAT-2400S & WAT-933 User's Manual

Rev. 1.10

Watec Co., Ltd.

2019/1/16

Revision Record

Rev.	Date	Changes
1.00	September 1, 2018	-
1.10	January 16, 2019	Upgrade to FW 2.0.0 . <ul style="list-style-type: none">• Updated the Exposure function• Added the Schedule function• Added the Timelapse function

ONVIF is a trademark of Onvif, Inc.

Table of Contents

1. Network connection and power activation of the camera.....	5
2. Connection of external MIC. IN.....	6
2.1. Corresponding terminal of external MIC. IN.....	6
2.2. External MIC. IN connection example	7
3. Connection of 4P cable.....	8
4. Network settings.....	9
4.1. This camera network default settings	9
4.2. Example of PC network settings	10
5. Checking the image from the camera	11
6. Changing the camera settings from the Web browser	14
6.1. How to access the configuration page	14
6.2. SYSTEM SETUP.....	16
6.2.1. User Information.....	16
6.2.2. Date & Time	17
6.2.3. Firmware Update.....	19
6.2.4. Save/Load Settings.....	20
6.2.5. Reset.....	22
6.3. IMAGE SETUP.....	23
6.3.1. IRIS	23
6.3.2. Exposure	24
6.3.3. Backlight.....	29
6.3.4. Color	32
6.3.5. Picture.....	35
6.3.6. Motion	39
6.3.7. Output Set	42
6.3.8. System.....	44
6.4. VIDEO SETUP	45
6.4.1. Video.....	45
6.4.2. H.264 View.....	54
6.4.3. JPEG View.....	56
6.5. NETWORK SETUP.....	57

6.5.1. Ethernet.....	57
6.6. SD CARD SETUP.....	59
6.6.1. Info	59
6.6.2. Schedule.....	61
6.6.3. Timelapse.....	63
6.7. How to initialize the camera setting.....	65
7. Reference.....	66
7.1. How to use ONVIF Device Manager.....	66
7.2. FTP Access	68
7.3. When streaming does not play on WEB setting page.....	69

1. Network connection and power activation of the camera

The WAT-933&WAT-2400S (simply called the “camera” from now on if there is no difference in the function “WAT-933” and “WAT-2400S”.) have two power supply systems. The one is powered by +12VDC input plug on rear panel of the camera, and the other is powered by the PoE using a LAN connector. When supplying power with DC + 12 V, use an independent power supply for each camera, and do not share power with other cameras and devices.

Please supply power by either the one or the other of the way above and do not supply the both power systems simultaneously.

The below figure is a connection example of the power supply by the PoE hub. In addition, you need to have the power individually to the router and the PoE hub.

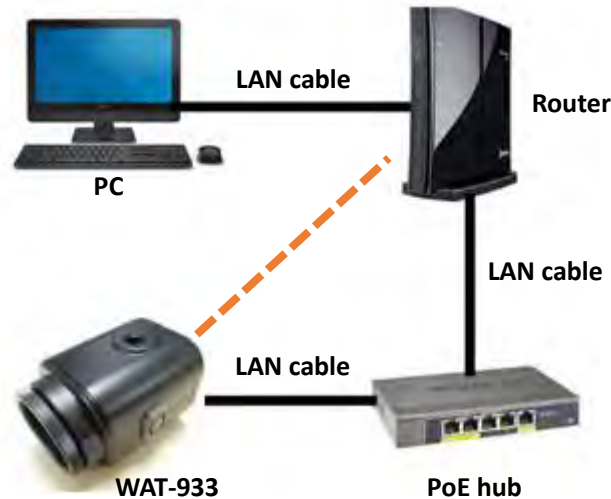

Figure 1. Network configuration example

Connect the LAN cable of camera side to the PoE port of the PoE hub and connect the LAN cable of the router side to a normal LAN port.

If you want to supply power to the camera using the AC power supplies, connect the camera and the router directly with exception of the PoE hub from the above. In a closed network configuration, the DHCP protocol and the router are not required. In that case, connect the PC and the camera directly in LAN cable.

It takes about 5 seconds to fully boot this camera from the power supply start.

2. Connection of external MIC. IN

This camera has the MIC. IN function.

You can use the internal MIC. IN attached to the camera, and the external MIC. IN.

Refer to "6.4.1.Video" for switching the internal MIC. IN and external MIC. IN.

The connection of external MIC. IN is explained below.

2.1. Corresponding terminal of external MIC. IN

When using the external MIC. IN, please use the electret condenser microphone of TRS, TS terminal or line input of RCA terminal.

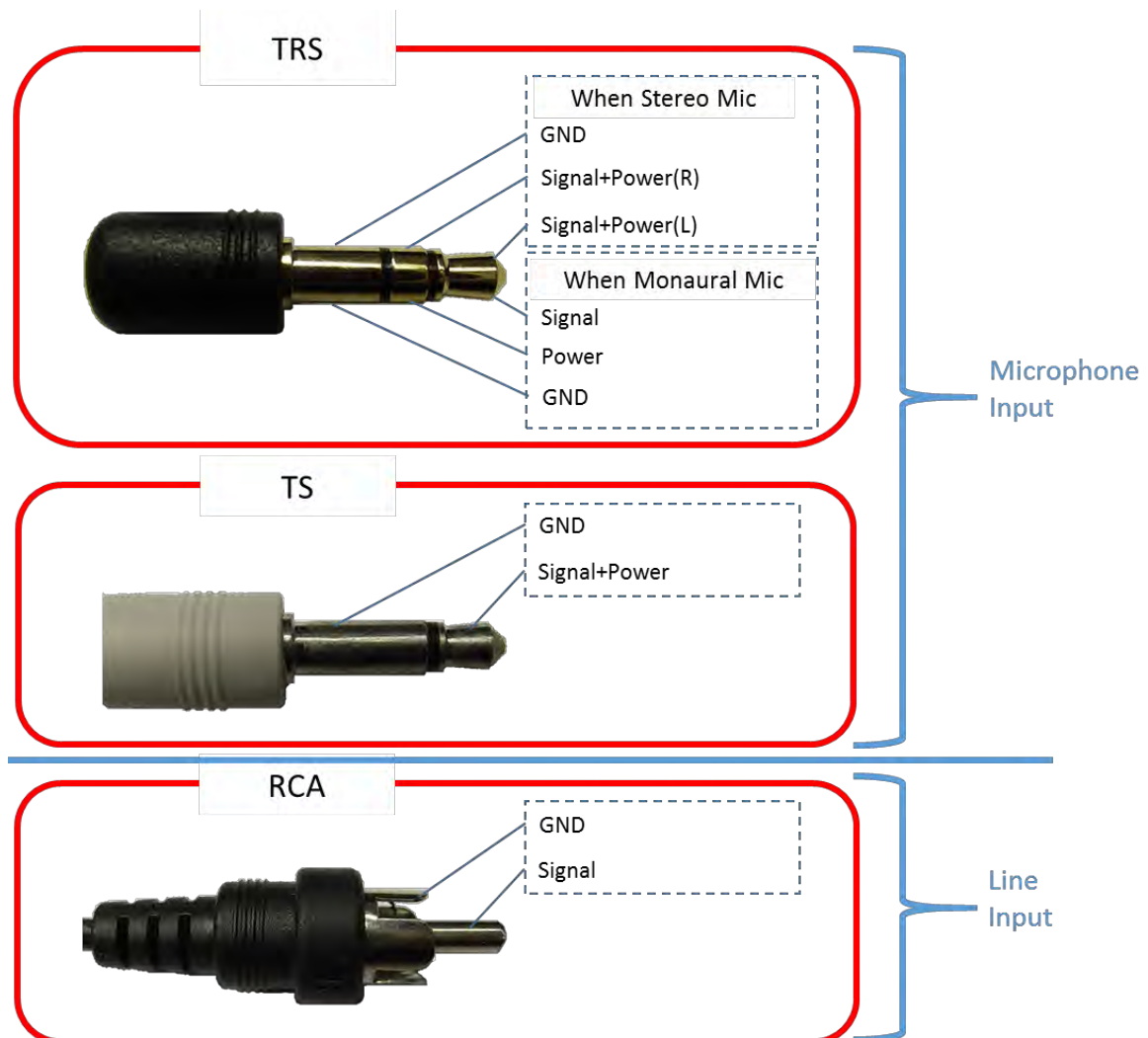

Figure 2. Corresponding terminal of external MIC. IN.

2.2. External MIC. IN connection example

Below is an example of connection of the input terminal.

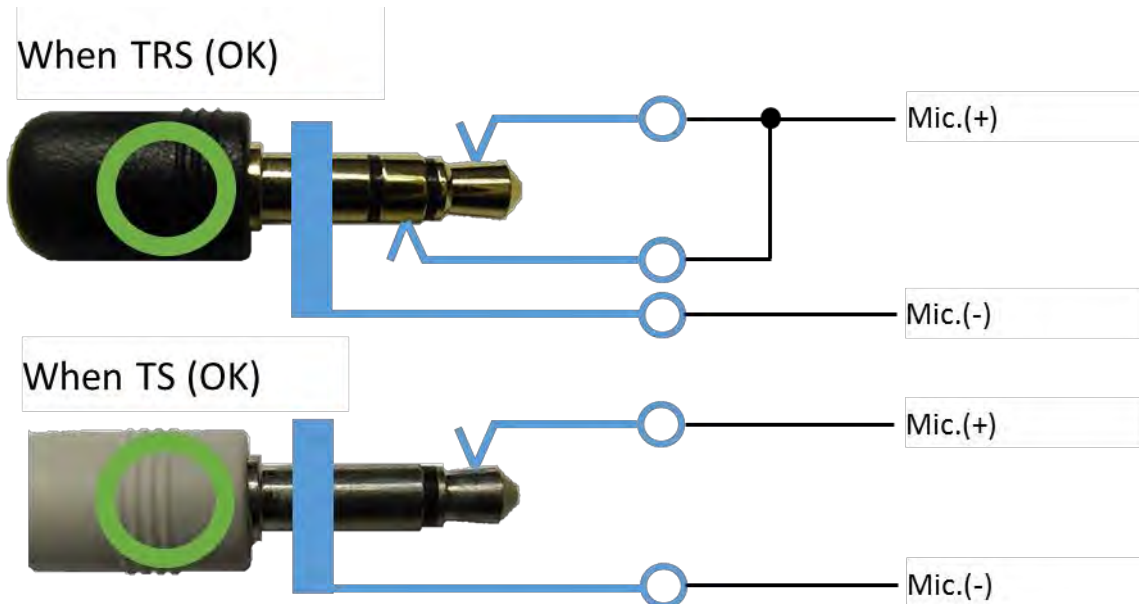

Figure 3. Correct connection example

If you connect as shown below, it will cause an accident, so please do not do it absolutely.

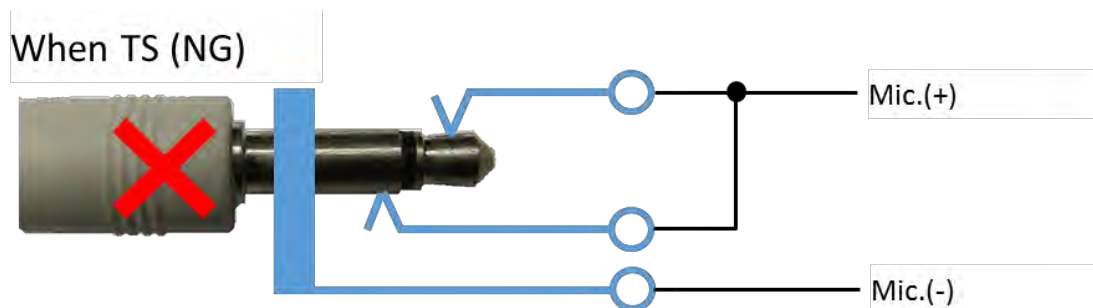

Figure 4. Wrong connection example

3. Connection of 4P cable

The wiring diagram of the included 4P cable for power supply / microphone input is as shown in the following figure.

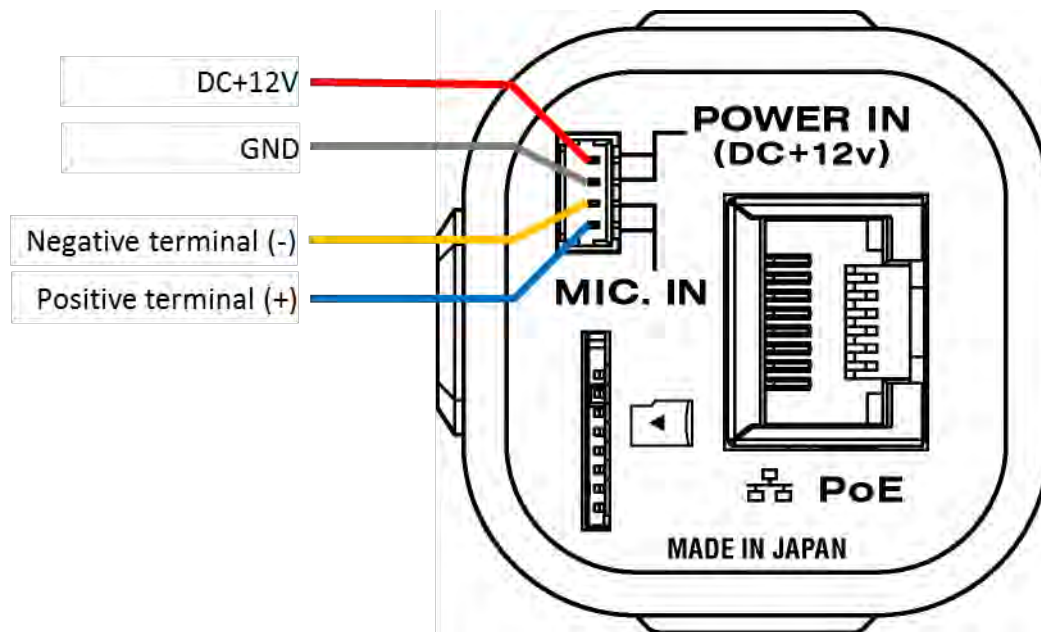

Figure 5. Wiring diagram of 4P cable

Note: Please note that contact of each terminal and exterior case may cause malfunction.
(The negative terminal has a different potential from the power supply GND terminal.)

4. Network settings

Before using the camera, you need to configure the network.

The network initial settings and the camera setting examples are described below.

4.1. This camera network default settings

The network default setting of this camera is as follows.

Table 1. Default settings of network

IP Address	192.168.1.250 (static)
Netmask	255.255.255.0
Gateway	192.168.1.1

The network settings of this camera can be changed by the Web browser which will be described later.

It is necessary to change the network setting of the PC and the camera according to the situation.

For details on changing the network settings of the camera, refer to "4.5.1.Ethernet" below.

It is possible that the setting has been changed by this camera you used once.

In that case, please contact this camera administrator.

If you do not know the IP address you set, you can reset it to factory default settings.

Refer to "4.7. Initialization method of this camera" below.

4.2. Example of PC network settings

Connect this camera and your PC as shown in the below figure. And if the network setting of the camera is in default configuration (IP Address: 192.168.1.250 (static)), go through the following steps to set up the PC network settings.



Figure 6. Minimum network configuration

Input the values as follow, click “OK” and close the property.

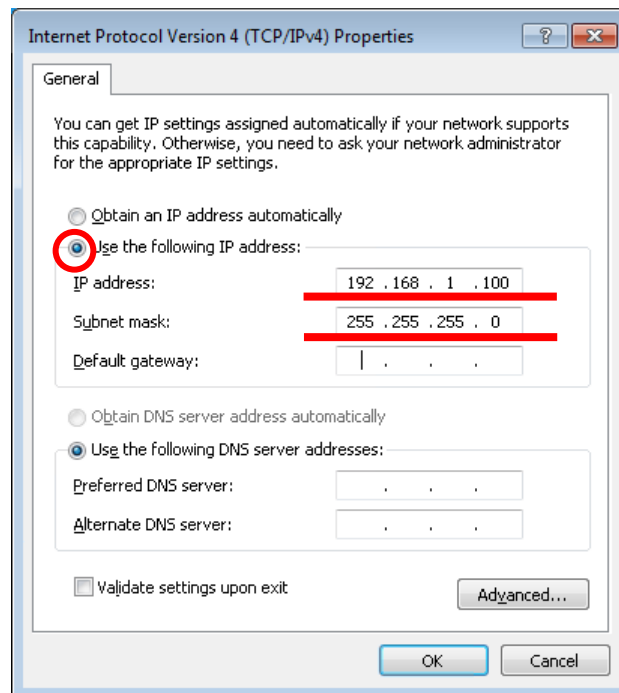

Figure 7. Internet protocol version 4 property window

5. Checking the image from the camera

You can check the video image after the network settings are completed.

This camera has the streaming format shown below.

Table 2. Streaming format

Name	Encode	Default resolution
H.264 Main	H.264	1920 * 1080
H.264 Sub		640 * 360
JPEG	MJPEG	1920 * 1080

Changes such as resolution and frame rate will be described later.

This section describes the method in the case of viewing the image from this camera using the VLC media player.

A case of VLC media player

Download the appropriate VLC which meets your PC from VideoLAN official download page (<https://www.videolan.org/vlc/index.html>) and install.

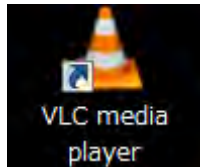

Open the VLC media player when the installation is complete.

Click on **Media <Open Network Stream** from the menu.

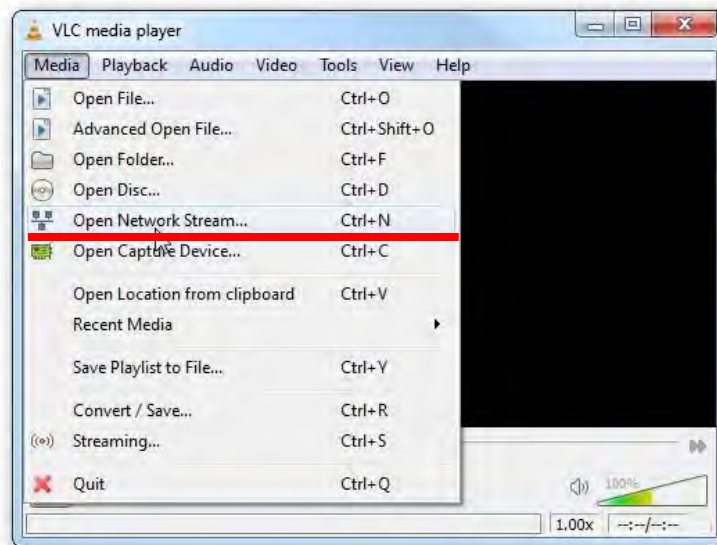

Figure 8. Setting to display video streaming with VLC (No.1)

Paste your copied URL in the 'Network Protocol' box and click "Play". Wait till the video start streaming in your VLC.

H.264 (main): rtsp:// "This camera IP Address" /h264

H.264 (sub): rtsp:// " This camera IP Address" /hsub

MJPEG: rtsp:// " This camera IP Address" /jpeg

(Example: rtsp://192.168.1.250/h264)

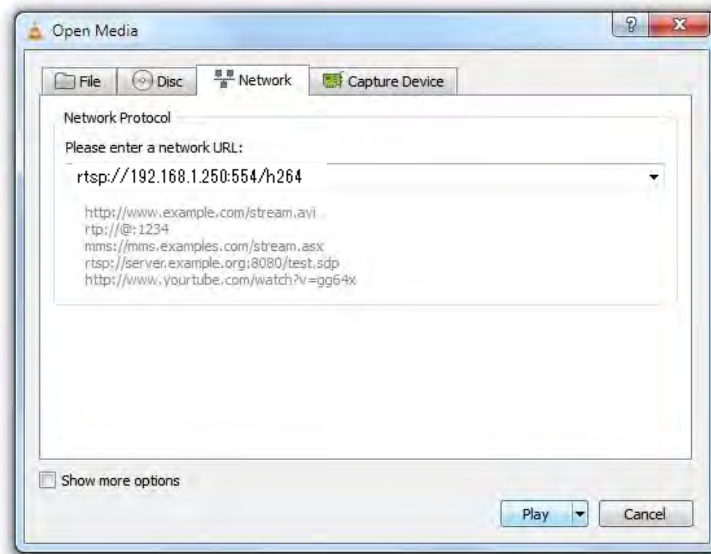

Figure 9. Setting to display video streaming with VLC (No.2)

Video starts to stream when the network connections and settings work property. Please check again the network settings if it does not start.

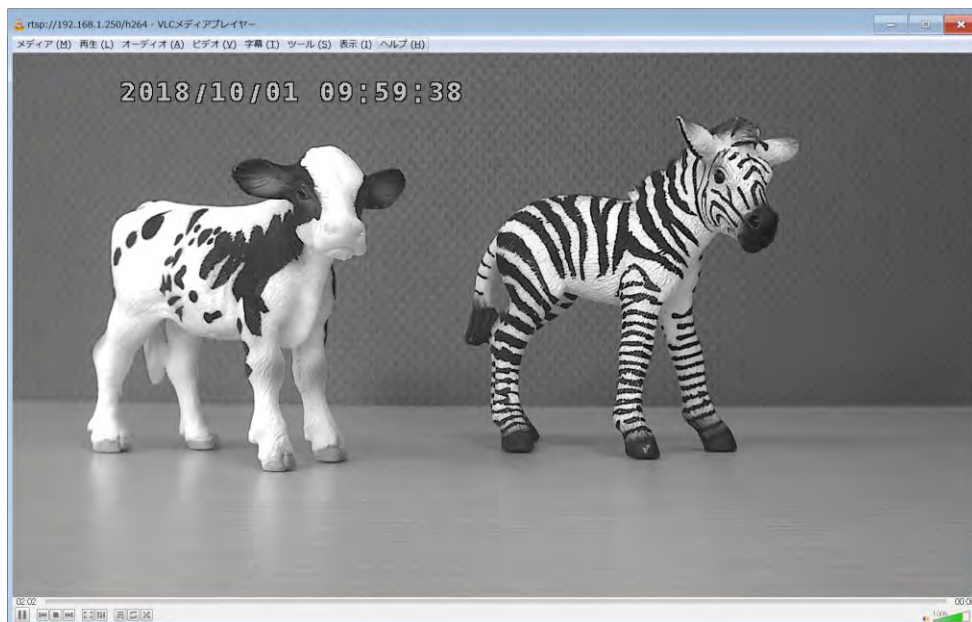

Figure 10. Streaming with VLC

The screen might become grey during the viewing, in that case, click the stop button in the lower left and click the play button again.

6. Changing the camera settings from the Web browser

On this camera you can change the configuration from the web browser.

The browser you use must correspond to html 5.

The recommended browser is Internet Explorer 11.

6.1. How to access the configuration page

Here's how to access the configuration page with a web browser.

Start the web browser and enter the following address.

[http://\"This camera IP Address\"/](http://\)

(Example: <http://192.168.1.250/>)

At the first time connection, the authentication window will open such as shown below.



Figure 11. IE window for authentication

User name: root

Password: 1234

Enter the above and click "OK".

The user name and password can be changed on the “4.2.1.User Information” described later.

Note: If the page does not switch even if you input authentication information, check the input characters. If the authentication window does not appear, restart the web browser.

6.1.1. WAT-933 System Configuration: Overview (top page)

Open your web browser and go to the following address page.

This page displays the overview. This page is the top page.

Note: SD CARD SETUP of the menu is displayed only when microSD card is inserted. If it is not displayed even though it is already inserted, please refresh the browser (F5).

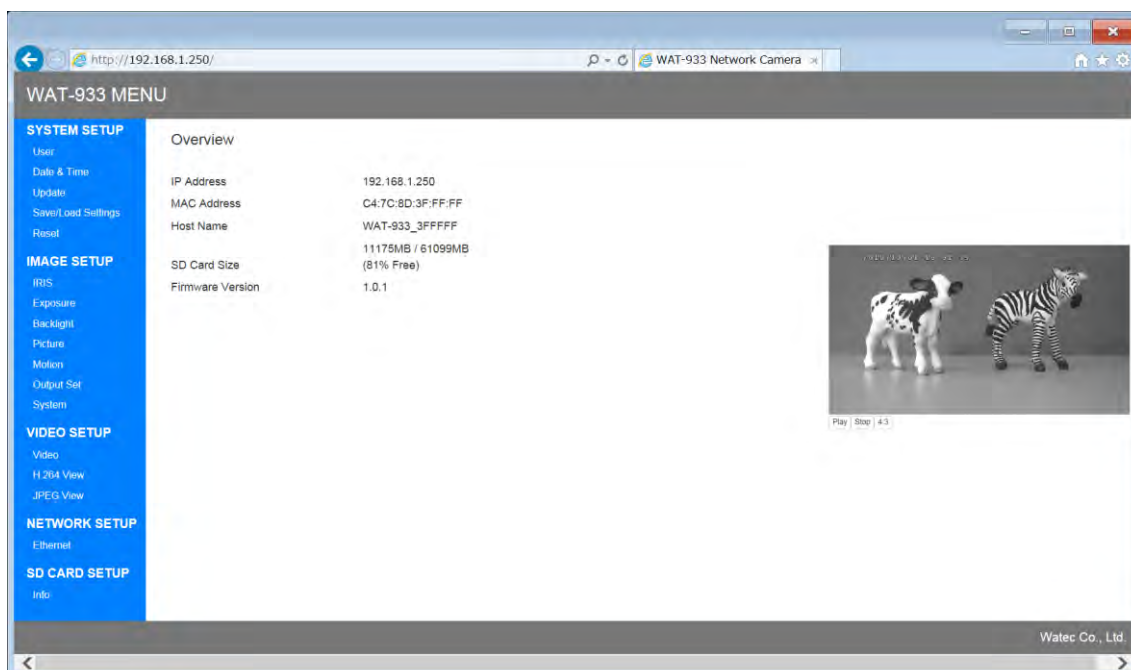

Figure 12. The Overview page (Top page)

The IP Address, MAC Address, Host Name, SD Card Size and Firmware Version of this camera are displayed. The SD Card Size is displayed only when the microSD card is inserted.

The setting menu of this camera is displayed on the left side of the page.

By clicking the link, you can display each setting page.

Each setting pages are explained below.

6.2. SYSTEM SETUP

6.2.1. User Information

Click “User” on menu to go to the User Information page.

Here you can set the ID and password used in each connection.

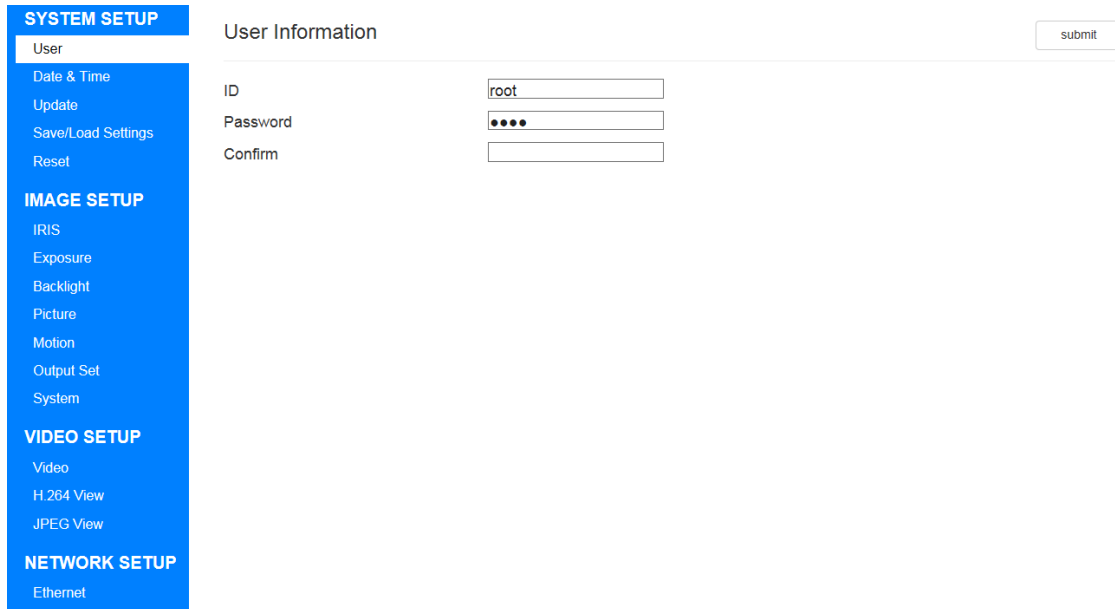

The screenshot shows a web interface for system setup. On the left is a blue sidebar menu with categories: SYSTEM SETUP (containing User, Date & Time, Update, Save/Load Settings, Reset), IMAGE SETUP (containing IRIS, Exposure, Backlight, Picture, Motion, Output Set, System), VIDEO SETUP (containing Video, H.264 View, JPEG View), and NETWORK SETUP (containing Ethernet). The 'User' option is selected. The main content area is titled 'User Information' and contains three input fields: 'ID' with the value 'root', 'Password' with masked characters '••••', and 'Confirm'. A 'submit' button is located in the top right corner of the main area.

Figure 13. The User Information page

ID

Set the ID to be used for each connection.

The default setting is "root".

Password, Confirm

Set the Password to be used for each connection.

Type your password once more in the Confirm Password box to ensure that it is correct.

If Confirm and Password do not match, the password will not be changed.

The default setting is "1234".

To update the setting value, please click “submit”.

Please attention that the authentication window will be displayed again when you change ID or Password.

The ID and Password set here are commonly used for WEB setting page, ONVIF and FTP.

6.2.2. Date & Time

Click “Date & Time” on menu to go to the Date & Time page.

Here you can set the time to use in this camera.

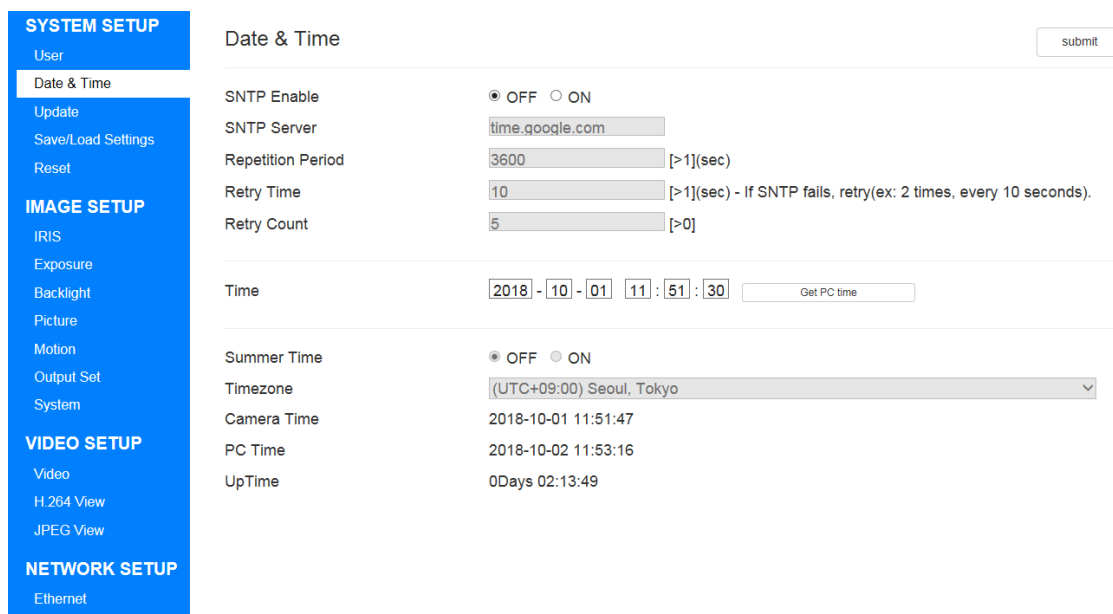

Figure 14. The Date & Time page

SNTP Enable

Use an external SNTP server to switch ON / OFF setting for time acquisition.

When this setting is ON, you can connect to the external SNTP server and synchronize time.

The default setting is “OFF”.

SNTP Server

It is enabled when SNTP Enable is ON.

Enter the IP address or server name of the external SNTP server.

The default setting is “time.google.com”.

Repetition Period

It is enabled when SNTP Enable is ON.

Set the Repetition Period for synchronization with the SNTP server.

The default setting is “3600”.

Retry Time

It is enabled when SNTP Enable is ON.

Set the retry time when connect to the SNTP server fails.

The default setting is "10".

Retry Count

It is enabled when SNTP Enable is ON.

Set the count of retries when connect to SNTP server fails.

The default setting is "2".

Time

Set the time of this camera.

You can match the client PC time with Get PC time.

Summer Time

It is enabled when SNTP Enable is OFF.

Switch ON / OFF used of summer time.

The default setting is OFF.

Timezone

It is enabled when SNTP Enable is OFF.

Select the time zone.

The default setting is "(UTC+09:00) Seoul, Tokyo".

Camera Time

The time of the camera is displayed.

PC Time

The time of the client PC is displayed.

UpTime

Displays the elapsed time since startup.

To update the setting value, please click the "submit" button.

6.2.3. Firmware Update

Click “Update” on menu to go to the Firmware Update page.

Here you can update the camera firmware.

The screenshot shows a web interface for firmware updates. On the left is a blue sidebar menu with sections: SYSTEM SETUP (User, Date & Time, Update, Save/Load Settings, Reset), IMAGE SETUP (IRIS, Exposure, Backlight, Picture, Motion, Output Set, System), VIDEO SETUP (Video, H.264 View, JPEG View), and NETWORK SETUP (Ethernet). The 'Update' option is highlighted. The main content area is titled 'Firmware Update' and has a 'submit' button. Below the title, there is a 'Version Info' section showing '1.0.1'. Underneath, there is a 'Firmware Path' section with a text input field and a 'Browse...' button.

Figure 15. The Firmware Update page

Version Info

Displays the current firmware version.

Firmware Path

Select the firmware file that exists on the client PC.

To update the firmware, select Firmware Path, and click “submit”.

When the firmware is correctly transmitted, a progress bar will be displayed.

When the progress bar reaches 100%, the reboot confirmation message will be displayed, so select OK.

Please attention that the authentication window will be displayed again when ID or Password has been changed on the “4.2.1.User Information”.

6.2.4. Save/Load Settings

Click “Save/Load Settings” on menu to go to the Save/Load Settings page.

Here you can save and load the camera setting values.

Example: As shown in Figure 12, you can load the configuration file saved from an individual with the same individual or load it with another individual.

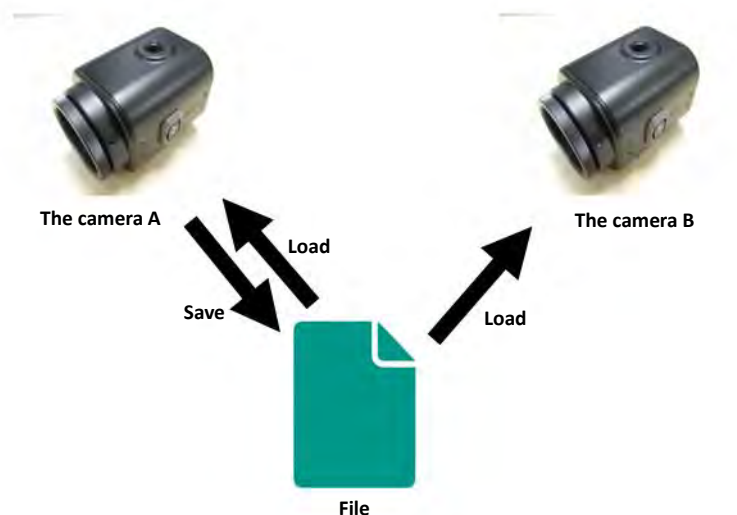

Figure 16. Example of using Save / Load Settings

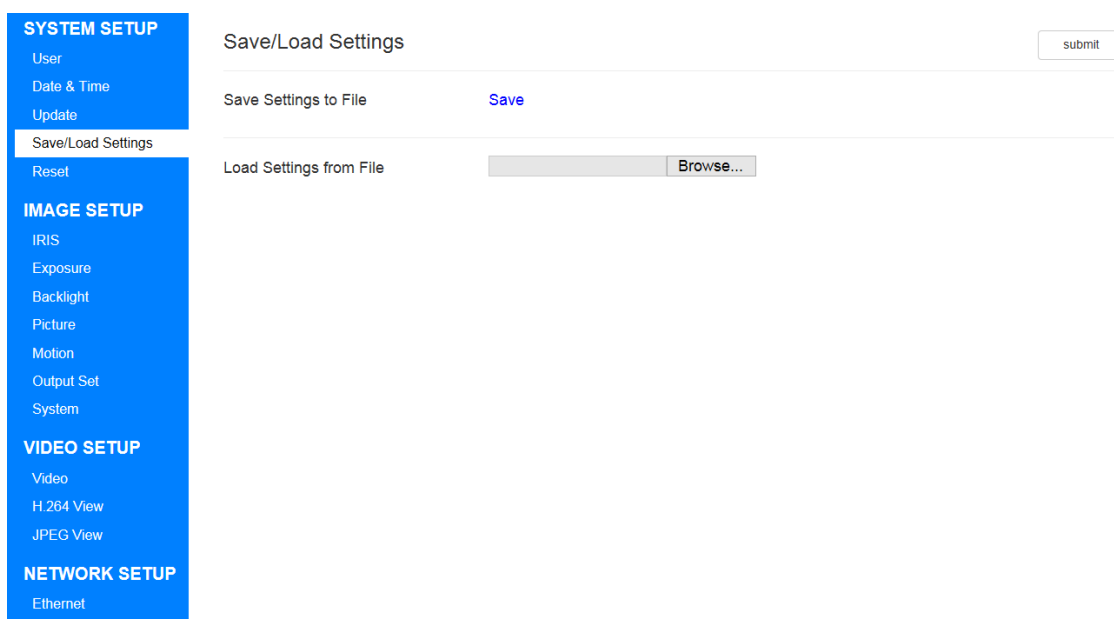

Figure 17. The Save/Load Settings page

Save Settings

Output the settings of this camera to a file and save it on the client PC.

The settings that can be saved are all settings that can be changed on the WEB setting page.

Click "Save" to save the configuration file (WAT-933_Setting.set or WAT-2400S_Setting.set) on the client PC.

Load Settings

Upload the file that output the settings of this camera from the client PC and load it.

Select the setting file (WAT-933_Setting.set or WAT-2400S_Setting.set) saved on the client PC.

To update the setting value, please click "submit".

When loading of the setting file is completed, a confirmation message of restart will be displayed. Please select "OK".

Please attention that the authentication window will be displayed again when ID or Password has been changed on the "4.2.1.User Information".

6.2.5. Reset

Click “Reset” on menu to go to the Reset page.

Here you can reset and reboot the camera.

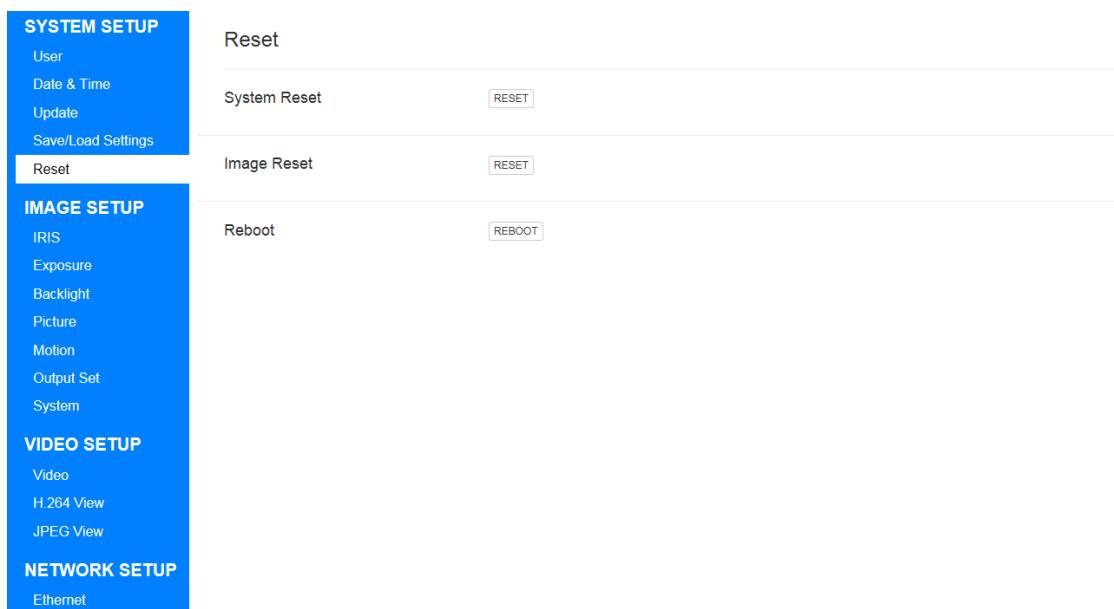

Figure 18. The Reset page

System Reset

Reset the settings other than IMAGE SETUP to the default settings.

It will be executed as soon as you click it.

Please attention that the authentication window will be displayed again when ID or Password has been changed on the User Information page.

Image Reset

Reset IMAGE SETUP to the default setting.

It will be executed as soon as you click it.

Reboot

Reboot the camera.

When you click on it, a reboot confirmation dialog will be displayed, select “OK” to reboot.

6.3. IMAGE SETUP

6.3.1. IRIS

Click “IRIS” on menu to go to the IRIS page.

Here you can set the IRIS mode.

The screenshot shows a web interface for camera settings. On the left is a blue sidebar with menu items grouped under 'SYSTEM SETUP', 'IMAGE SETUP', 'VIDEO SETUP', and 'NETWORK SETUP'. The 'IRIS' option under 'IMAGE SETUP' is highlighted. The main content area is titled 'IRIS' and has a 'submit' button in the top right corner. Below the title, there is a 'Mode' label followed by a dropdown menu currently showing 'ELC'.

Figure 19. The IRIS page

Mode

Select from the following 2.

Table 3. Selectable items of Mode

1	ELC	Electronic shutter control. Exposure control is performed with shutter speed and AGC, and the IRIS lens is fully opened.
2	ALC	Auto iris control. Exposure control is performed with iris and AGC, and the shutter speed is fixed.

The default setting is “ELC”.

To update the setting value, please click the “submit” button.

6.3.2. Exposure

Click “Exposure” on menu to go to the EXPOSURE page.

Here you can set the exposure, brightness, gain, etc. of the sensor.

Setting	Value	Range
Brightness	10	[0~20]
ANTI-SAT	OFF	OFF, ON
WEIGHT	10	[0~20]
LEVEL	10	[0~20]
STABILIZING	HIGH	
BACKLIGHT	HIGH	
AE SPEED	MIDDLE	
Shutter	Auto	
Mode	Normal	
Speed	1/30	
Slow Shutter	OFF	
AGC MAX	72	[0~72] dB
AGC MIN	0	[0~72]

Figure 20. The EXPOSURE page

Brightness

Set the brightness of the image.

It can be set between 0 ~ 20.

The smaller the value, the darker it is, the larger it gets brighter.

The default setting is “10”.

ANTI-SAT

Turn ON/OFF the function improving the video saturation caused by light.

Set the degrees of improving the saturation of light areas.

The default setting is “OFF”.

WEIGHT

The higher the value, the darker the surrounding area gets when improving saturation of light areas.

The default setting is “10”.

LEVEL

Brightness settings for light areas recognition. If both light and surrounding areas are very bright, the value of LEVEL should be set high for recognizing light areas.

Note: If the sky that is very bright at daytimes is saturated, the LEVEL should be set high to recognize light areas and improve saturation.

The default setting is "10".

STABILIZING

Set the control stabilization level for light areas video changes.

It can be selected from LOW / MIDDLE / HIGH / OFF.

The default setting is "HIGH".

BACKLIGHT

Automatically corrects surrounding areas that is darkened by saturation improvement of light areas through Digital Gamma.

It can be selected from LOW / MIDDLE / HIGH.

The default setting is "HIGH".

AE SPEED

Set the AE control speed.

It affects speed of shutter speed and iris change.

It can be selected from LOW / MIDDLE / HIGH.

It becomes late when it is LOW, and it becomes faster when it is HIGH.

The default setting is "MIDDLE".

Shutter

Select from the following 3.

Table 4. Selectable items of Shutter

1	Auto	When Mode of "4.3.1.IRIS" is ELC, shutter speed is automatically controlled. For ALC, fix the shutter speed to 1/30 or 1/25.
2	Manual	Set the shutter speed to an arbitrary fixed value. (See Table 7)
3	Flicker	Fix the shutter speed at 1/100 or 1/120, reducing the flicker phenomenon.

The default setting is "Auto".

Mode

It is enabled when Shutter is "Auto".

This items that can be selected differ depending on the Mode setting on the "4.3.1. IRIS".

When Mode of the "4.3.1.IRIS" is ELC, select from the following two.

Table 5. Selectable items of Mode (When IRIS Mode is ELC)

1	Normal	Normal mode.
2	Deblur	Adjusting the shutter speed and AGC will reduce motion blur.

When Mode of "4.3.1.IRIS" is ALC, select from the following two.

Table 6. Selectable items of Mode (When IRIS Mode is ALC)

1	Indoor	Exposure control is performed by normal IRIS control.
2	Outdoor	Adjust the shutter speed so as not to excessively narrow the IRIS in a strong light environment.
3	Deblur	Adjusting the shutter speed and AGC will reduce motion blur.

The default setting is "Normal".

Speed

It is enabled when Shutter is Manual.

The select items will change according to the Frequency of the "4.3.7. OUTPUT SET" which will be described later.

List items that can be selected below.

Table 7. Selectable items of Speed

When Frequency is 60Hz	When Frequency is 50Hz
1/30	1/25
1/60	1/50
1/120	1/100
1/250	1/200
1/500	1/400
1/1000	1/800
1/2000	1/1600
1/4000	1/3200
1/8000	1/6400
1/15000	1/12800
1/30000	1/25600

The default setting is "1/30" or "1/25".

Slow Shutter

It is disable when shutter is Manual.

It is also disable when Mode of the Output Set page which will be described later is 15 fps WDR or 12 fps WDR.

The slow shutter increases the sensitivity.

It can be selected from OFF / x2 / x4 / x8 / x16 / x32.

The default setting is "OFF".

AGC MAX

Set the maximum gain.

It can be set between 0 ~ 72 dB.

The default setting is "72".

AGC MIN

Set the minimum gain.

It can be set between 0 ~ 72 dB.

Note: Setting a value higher than the AGC MAX will automatically have the same value as the AGC MAX.

The default setting is "0".

Note: Relationship between AGC and Slow Shutter

When both AGC and Slow Shutter are working, exposure control by AGC takes precedence. Therefore, as shown in the figure, Slow Shutter may not work if it converges to the target brightness only with AGC.

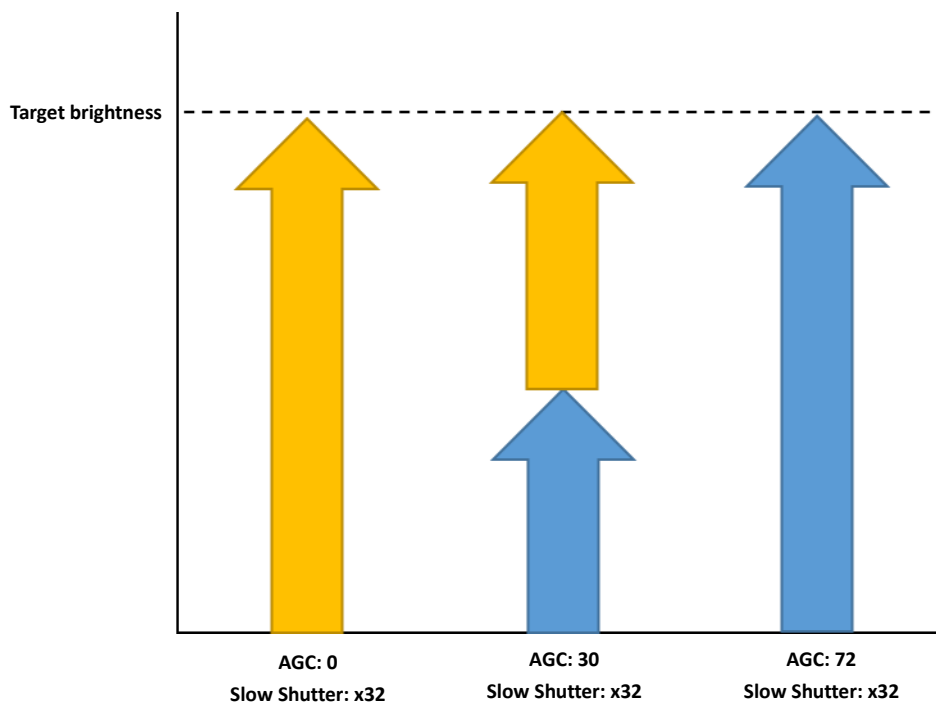

Figure 21. Relationship between AGC and Slow Shutter

To update the setting value, please click the "submit" button.

6.3.3. Backlight

Click “Backlight” on menu to go to the BACKLIGHT page.

Here you can set the backlight and highlight compensation.



Figure 22. The BACKLIGHT page

Mode

It is disable when Mode of the “4.3.7.Output Set” which will be described later is 15 fps WDR or 12 fps WDR.

Select from the following 3.

Table 8. Selectable items of Mode

1	OFF	Backlight compensation is not used.
2	HLC	Highlight compensation is used. Highlight compensation is aimed at reducing the burden on the observer by improving the visibility by applying mask processing to intense light.
3	BLC	Backlight compensation is used. Backlight compensation is to increase the brightness of the entire image and make the subject that is blackened by backlighting to the appropriate brightness.

The default setting is “OFF”.

HLC - Level

It is enabled when Mode is "HLC".

Set the mask brightness level.

It can be set between 0 ~ 20.

The smaller the value, the lower the brightness threshold of the mask, and the larger the value, the higher the brightness threshold of the mask.

The default setting is "10".

HLC - Color

It is enabled when Mode is "HLC".

Set the mask color.

You can select from WHT / YEL / CYN / GRN / MAG / RED / BLU / BLK.

The default setting is "BLK".

BLC – BLC OSD ON

It is enabled when Mode is "BLC".

Set visibility of backlight compensation area.

The default setting is "OFF".

BLC - H position

It is enabled when Mode is "BLC".

Set the horizontal start position of the backlight compensation area.

It can be set between 0 ~ 20.

The smaller the value, to the left moves, and the larger the value, to the right moves.

The default setting is "8".

BLC - V position

It is enabled when Mode is "BLC".

Set the vertical start position of the backlight compensation area.

It can be set between 0 ~ 20.

The smaller the value, to the up moves, and the larger the value, to the down moves.

The default setting is "7".

BLC - H size

It is enabled when Mode is "BLC".

Set the horizontal size of the backlight compensation area.

It can be set between 0 ~ 20.

The smaller the value, to the left moves, and the larger the value, to the right moves.

The default setting is "3".

BLC - V size

It is enabled when Mode is "BLC".

Set the vertical size of the backlight compensation area.

It can be set between 0 ~ 20.

The smaller the value, to the up moves, and the larger the value, to the down moves.

The default setting is "3".

To update the setting value, please click "submit".

6.3.4. Color

Click “Color” on menu to go to the COLOR page.

Here you can set such as the auto white balance.

This page is only WAT-2400S

The screenshot shows the 'COLOR' configuration page. On the left is a blue sidebar menu with the following items: SYSTEM SETUP (User, Date & Time, Update, Save/Load Settings, Reset), IMAGE SETUP (IRIS, Exposure, Backlight, Color, Picture, Motion, Output Set, System), VIDEO SETUP (Video, H.264 View, JPEG View), NETWORK SETUP (Ethernet), and SD CARD SETUP (Info). The 'Color' item is highlighted. The main content area is titled 'COLOR' and includes a 'submit' button in the top right. The settings are: AWB (dropdown menu set to 'AUTO'), Color Gain (input field with '25' and range '[0~40]'), Preset (radio buttons for 'Idle' (selected) and 'SET'), Manual C Temp (dropdown menu set to '5000K'), R Gain (input field with '10' and range '[0~20]'), and B Gain (input field with '10' and range '[0~20]').

Figure 23. The COLOR page

AWB

Set the auto white balance.

Select from the following four.

Table 9. Selectable items of AWB

1	AUTO	Automatically performs white balance control.
2	AUTOext	White balance control is automatically performed at a color temperature range wider than AUTO.
3	PRESET	The white balance can be automatically corrected according to the environment, and the compensation value can be fixed. Please see Preset below for details.
4	MANUAL	You can select from a predetermined color temperature.

The default setting is “AUTO”.

Color Gain

Set the color gain.

It can be set between 0~40.

The smaller the value, the lower the saturation, and the larger the value, the higher the saturation.

The default setting is "25".

Preset

It is enabled when AWB is "PRESET".

Set the preset white balance.

You can be select from Idle / SET.

When this item is set to SET, the white balance is automatically adjusted according to the usage environment.

When this item is set to idle, the adjusted white balance is fixed.

The default setting is "Idle".

C Temp

It is enabled when AWB is "MANUAL".

Set the color temperature.

You can be select from 3000K / 5000K / 8000K.

The default setting is "5000K".

R Gain

It is enabled when AWB is "MANUAL".

Set the red gain.

It can be set between 0~20.

The smaller the value, the negative compensation is applied to the R component.

The larger the value, the positive compensation is applied to the R component.

The default setting is "10".

B Gain

It is enabled when AWB is "MANUAL".

Set the blue gain.

It can be set between 0~20.

The smaller the value, the negative compensation is applied to the B component.

The larger the value, the positive compensation is applied to the B component.

The default setting is "10".

6.3.5. Picture

Click “Picture” on menu to go to the PICTURE page.

Here you can set such as the sharpness, contrast of the image.

SYSTEM SETUP

- User
- Date & Time
- Update
- Save/Load Settings
- Reset

IMAGE SETUP

- IRIS
- Exposure
- Backlight
- Picture**
- Motion
- Output Set
- System

VIDEO SETUP

- Video
- H 264 View
- JPEG View

NETWORK SETUP

- Ethernet

PICTURE

Sharpness: [0~10]

Gamma:

Mirror: OFF ON

Flip: OFF ON

ACE:

Defog: OFF ON

Mode:

Level:

Privacy: OFF ON

Mask mode:

Y level: [0~20]

CB level: [0~20]

CR level: [0~20]

Trans: [0~3]

Privacy Zone

Zone	H-POS	V-POS	H-SIZE	V-SIZE	Submit
Disp	[0~60]	[0~34]	[0~60]	[0~34]	
0	<input type="text" value="8"/>	<input type="text" value="2"/>	<input type="text" value="3"/>	<input type="text" value="3"/>	<input type="button" value="submit"/>
1	<input type="text" value="12"/>	<input type="text" value="2"/>	<input type="text" value="3"/>	<input type="text" value="3"/>	<input type="button" value="submit"/>
2	<input type="text" value="16"/>	<input type="text" value="2"/>	<input type="text" value="3"/>	<input type="text" value="3"/>	<input type="button" value="submit"/>
3	<input type="text" value="20"/>	<input type="text" value="2"/>	<input type="text" value="3"/>	<input type="text" value="3"/>	<input type="button" value="submit"/>
4	<input type="text" value="24"/>	<input type="text" value="2"/>	<input type="text" value="3"/>	<input type="text" value="3"/>	<input type="button" value="submit"/>
5	<input type="text" value="28"/>	<input type="text" value="2"/>	<input type="text" value="3"/>	<input type="text" value="3"/>	<input type="button" value="submit"/>
6	<input type="text" value="8"/>	<input type="text" value="6"/>	<input type="text" value="3"/>	<input type="text" value="3"/>	<input type="button" value="submit"/>
7	<input type="text" value="12"/>	<input type="text" value="6"/>	<input type="text" value="3"/>	<input type="text" value="3"/>	<input type="button" value="submit"/>
8	<input type="text" value="16"/>	<input type="text" value="6"/>	<input type="text" value="3"/>	<input type="text" value="3"/>	<input type="button" value="submit"/>
9	<input type="text" value="20"/>	<input type="text" value="6"/>	<input type="text" value="3"/>	<input type="text" value="3"/>	<input type="button" value="submit"/>
10	<input type="text" value="24"/>	<input type="text" value="6"/>	<input type="text" value="3"/>	<input type="text" value="3"/>	<input type="button" value="submit"/>
11	<input type="text" value="28"/>	<input type="text" value="6"/>	<input type="text" value="3"/>	<input type="text" value="3"/>	<input type="button" value="submit"/>
12	<input type="text" value="8"/>	<input type="text" value="10"/>	<input type="text" value="3"/>	<input type="text" value="3"/>	<input type="button" value="submit"/>
13	<input type="text" value="12"/>	<input type="text" value="10"/>	<input type="text" value="3"/>	<input type="text" value="3"/>	<input type="button" value="submit"/>
14	<input type="text" value="16"/>	<input type="text" value="10"/>	<input type="text" value="3"/>	<input type="text" value="3"/>	<input type="button" value="submit"/>
15	<input type="text" value="20"/>	<input type="text" value="10"/>	<input type="text" value="3"/>	<input type="text" value="3"/>	<input type="button" value="submit"/>

Figure 24. The PICTURE page

Sharpness

Set the sharpness.

It can be set between 0 and 10.

The smaller the value, the lower the sharpness, and the larger the value, the higher the sharpness.

The default setting is "5".

Gamma

Set the gamma correction.

It can be selected from 0.45 / 0.55 / 0.65 / 0.75.

The default setting is "0.55".

Mirror

Switch ON / OFF of left / right reversal.

The default setting is "OFF".

Flip

Switch ON / OFF of upside-down.

The default setting is "OFF".

ACE

Set the contrast.

It can be selected from OFF / LOW / MIDDLE / HIGH.

The default setting is "OFF".

Defog

Switch ON / OFF use of defog correction.

Defog correction improves visibility deteriorated by fog, snow, dust etc.

The default setting is "OFF".

Defog - Mode

It is enabled when Defog is "ON".

It can be selected from MANUAL / AUTO.

When this item is MANUAL, fog correction is always performed.

When this item is AUTO, fog correction is automatically performed as necessary.

The default setting is "AUTO".

Defog - Level

It is enabled when Defog is "ON".

It can be selected from LOW / MIDDLE / HIGH.

The default setting is "MIDDLE".

Privacy

Switch ON / OFF use of privacy mask.

The default setting is "OFF".

Mask mode

It is enabled when Privacy is "ON".

It can be selected from FILL / FORMAT.

When this item is FILL, fill the mask area.

When this item is FORMAT, make the mask area black and white reversed.

The default setting is "FILL".

Y level

It is enabled when Privacy is "ON".

Set the brightness of the mask color.

It can be set between 0 ~ 20.

The smaller the value, the lower the brightness, and the larger the value, the higher the brightness.

The default setting is "10".

CB level

It is enabled when Privacy is "ON".

Set the intensity of the B component of the mask color.

It can be set between 0 ~ 20.

The smaller the value, the lower the intensity of B component, the larger value, the higher the intensity of B component.

The default setting is "10".

CR level

It is enabled when Privacy is "ON".

Set the intensity of the R component of the mask color.

It can be set between 0 ~ 20.

The smaller the value, the lower the intensity of R component, the larger value, the higher the intensity of R component.

The default setting is "10".

Trans

It is enabled when Privacy is "ON".

Set the transparency of the mask.

It can be set between 0 ~ 3.

The smaller the value, the lower the transparency, the larger the value, the higher the transparency.

The default setting is "0".

Privacy Zone

It is enabled when Privacy is "ON".

A total of 15 masks can be set.

The setting items of each mask are explained below.

- A) Zone Disp
Switch display ON / OFF of each mask.
- B) H-POS
Sets the horizontal start position of each mask.
- C) V-POS
Sets the vertical start position of each mask.
- D) H-SIZE
Sets the horizontal size of each mask.
- E) V-SIZE
Sets the vertical size of each mask.
- F) submit
Updates the setting of each mask.

To update the setting value, please click "submit".

Please attention that you need to click "submit" next to each mask setting when updating the setting of each mask.

6.3.6. Motion

Click “Motion” on menu to go to the MOTION page.

Here you can set motion detection.

Zone Disp	H-POS [0~60]	V-POS [0~34]	H-SIZE [0~60]	V-SIZE [0~34]	Submit
0	1	1	58	32	submit
1	10	11	20	11	submit
2	30	22	20	11	submit
3	50	33	20	11	submit

Figure 25. The MOTION page

MOTION

Switch ON / OFF use of the motion detection.

The default setting is “OFF”.

DETECTION TONE

It is enabled when MOTION is “ON”.

Set the display method of effective area of motion detection.

It can be set between 0 ~ 4.

Table 10. Selectable items of DETECTION TONE

0	The detection range is displayed with a white frame.
1	The detection range is displayed with the transparent frame.
2	The detection range is displayed as a transparent frame with higher transparency than 1.
3	The detection range is not displayed.
4	The detection range is displayed with the thin green frame.

The default setting is “2”.

MDRECT FILL

It is enabled when MOTION is "ON".

Switch the ON / OFF of the fill of the motion detection area.

The default setting is "ON".

SENSITIVITY

It is enabled when MOTION is "ON".

Set the sensitivity of motion detection.

It can be set between 0 ~ 10.

The smaller the value, the lower the sensitivity, and the larger the value, the higher the sensitivity.

The default setting is "5".

MOTION OSD

It is enabled when MOTION is "ON".

Switch ON / OFF of OSD display at motion detection.

The default setting is "ON".

TEXT ALARM

It is enabled when MOTION is "ON".

Switch ON / OFF of the text display of motion detection.

The default setting is "ON".

Motion Zone

It is enabled when MOTION is "ON".

Sets the motion detection zone.

A total of 4 motion detection zones can be set.

The setting items of each zone are explained below.

- A) Zone Disp
Switch ON / OFF enable of each zone.
- B) H-POS
Sets the horizontal start position of each zone.
- C) V-POS
Sets the vertical start position of each zone.
- D) H-SIZE
Sets the horizontal size of each zone.
- E) V-SIZE
Sets the vertical size of each zone.
- F) submit
Update the setting of each zone.

To update the setting value, please click "submit".

Please attention that you need to click "submit" next to each zone setting when updating the setting of each zone.

6.3.7. Output Set

Click “Output” Set on menu to go to the OUTPUT SET page.

Here you can set Sensor output.

Figure 26. The OUTPUT SET page

Mode

The settings that can be selected will change depending on the Frequency setting described below.

When Frequency is 60Hz, select from the following 3.

Table 11. Selectable items of Mode (When Frequency is 60Hz)

1	30fps Normal	Takes with 30fps Normal.
2	15fps WDR	Takes with 15fps wide dynamic range. The wide dynamic range is a setting that combines two frames with different exposure times and expands the dynamic range.
3	30fps DNR	Takes with 30fps dynamic noise reduction.

When Frequency is 50Hz, select from the following 3.

Table 12. Selectable items of Mode (When Frequency is 50Hz)

1	25fps Normal	Takes with 25fps Normal.
2	12fps WDR	Takes with 12fps wide dynamic range.
3	25fps DNR	Takes with 25fps dynamic noise reduction.

The default setting is “30fps Normal” or “25fps Normal”.

Level

It is enabled when Mode is 15fps WDR / 30fps DNR / 12fps WDR / 25fps DNR.

It can be selected from LOW / MIDDLE / HIGH.

The default setting is "HIGH".

Frequency

It can be selected from 50Hz / 60Hz.

The default setting is "60Hz".

To update the setting value, please click "submit".

6.3.8. System

Click “System” on menu to go to the SYSTEM page.

Here you can set Color bar and Title.

The screenshot shows a web interface for system configuration. On the left, a blue sidebar lists menu categories: SYSTEM SETUP, IMAGE SETUP, VIDEO SETUP, and NETWORK SETUP. Under SYSTEM SETUP, several options are listed, with 'System' highlighted. The main content area is titled 'SYSTEM' and features a 'submit' button in the top right. Two settings are visible: 'Color bar' with radio buttons for 'OFF' (selected) and 'ON', and 'Cam Title' with a dropdown menu set to 'OFF' and a text input field containing '00000000'.

Figure 27. The SYSTEM page

Color bar

Switch ON / OFF of the Color bar.

The default setting is “OFF”.

Cam Title

You can set the title to be displayed to the image.

It can be selected from OFF / Right up / Left down.

The title is allowed 8 alphanumeric characters.

To update the setting value, please click “submit”.

6.4. VIDEO SETUP

6.4.1. Video

Click “Video” on menu to go to the Video Information page.

Here you can set streaming etc.

The screenshot shows the 'Video Information' configuration page. On the left is a blue sidebar with navigation menus: SYSTEM SETUP (User, Date & Time, Update, Save/Load Settings, Reset), IMAGE SETUP (IRIS, Exposure, Backlight, Color, Picture, Motion, Output Set, System), VIDEO SETUP (Video, H.264 View, JPEG View), NETWORK SETUP (Ethernet), and SD CARD SETUP (Info, Schedule, Timelapse). The main content area is titled 'Video Information' and includes a 'submit' button in the top right. The settings are organized into three sections: H.264 Main, H.264 Sub, and M-JPEG. Each section has a 'submit' button. The H.264 Main section includes Max Resolution (1920 X 1080), Max FPS (30FPS), Output Mode (30FPS Normal), RTSP Port (554), Select Recording (H.264 MAIN), Timestamp Display (ON), Mix Audio with Streaming & Recoding (ON), and Select Audio (INTERNAL MICROPHONE). The H.264 Sub section includes H.264 Profiles (Baseline), H.264 Resolution (1920x1080), H.264 Quality (50), H.264 GOP (IDR) (30), H.264 FPS (30fps), Bitrate Control (CBR), and H.264 Sub Bitrate (10Mbit). The M-JPEG section includes M-JPEG Resolution (1920x1080), M-JPEG Quality (50), M-JPEG FPS (30fps), Bitrate Control (CBR), and M-JPEG Bitrate (20Mbit).

Figure 28. The Video Information page

Max Resolution

It display the maximum size that can be streamed.

Max FPS

It display the maximum framerate that can be streamed.

Output Mode

Display the current sensor output mode.

RTSP Port

Configure the port of the RTSP protocol.

The default setting is "554".

Select Recording

Select recorded streaming of microSD card.

It can be selected from H.264 MAIN / H.264 SUB.

The default setting is "H.264 MAIN".

Timestamp Display

Switch ON / OFF of the Timestamp.

The default setting is "ON".

Mix Audio with Streaming & Recoding

Switch audio input ON / OFF.

The default setting is "ON".

Select Audio

Select the audio input mode from the following 3.

Table 13. Selectable items of Select Audio

1	INTERNAL MICROPHONE	Use the included microphone.
2	EXTERNAL AUDIO	Use external input.
3	MIX BOTH	Use both.

The default setting is "INTERNAL MICROPHONE".

H.264 Main

H.264 Profiles

H.264 Main Select compression profile for streaming.

It can be selected from Baseline / Main.

For the same bit rate, the Main Profile tends to have higher image quality.

However, please note that some playback devices may not support Main Profile.

The default setting is "Baseline".

H.264 Resolution

H.264 Main Selects the resolution size of the streaming.

Table 14. Selectable items of H.264 Resolution

H.264 Resolution
1920x1080
1280x720
800x600
704x480
704x400
640x480
640x360
320x240

The default setting is "1920x1080".

H.264 Quality

It is enable when the Bitrate Control described later is "VBR".

Set compression quality.

It can be set between 10 ~ 51.

The smaller the value, the higher the quality, and the larger the value, the lower the quality.

The default setting is "50".

H.264 GOP (IDR)

H.264 Main Set compression GOP for streaming.

It can be set between 1 ~ 150.

The smaller the value, the lower the compression rate, but the faster the seek time.

The larger the value, the higher the compression rate, but the seek time will be slower.

The default setting is "30".

H.264 FPS

H.264 Main Set framerate for streaming.

Depending on the Frequency setting on the “4.3.7.Output Set”, the items that can be selected will change.

List items that can be selected below.

Table 15. Selectable items of H.264 FPS

When Frequency is 60Hz	When Frequency is 50Hz
30fps	25fps
15fps	5fps
10fps	1fps
6fps	-
5fps	-
3fps	-
2fps	-
1fps	-

The default setting is “30fps” or “25fps”.

Bitrate Control

H.264 Main Select compression method for streaming from the following 2 methods.

Table 16. Selectable items of Bitrate Control

1	VBR	<p>Variable Bitrate.</p> <p>Quality is constant, and bitrate is variable.</p> <p>Since the bit rate changes according to the subject, network bandwidth can be used efficiently.</p> <p>However, since the bandwidth used is not constant, it is difficult to design the network.</p>
2	CBR	<p>Constant Bitrate.</p> <p>Bitrate is constant, and quality is variable.</p> <p>Because the bandwidth used is constant, network design is easy.</p> <p>However, depending on the subject, the bandwidth may be wasted, or the image quality may be poor.</p>
3	CVBR	<p>Constant Variable Bitrate.</p> <p>In H.264, the data size is reduced by putting the difference data (P-frame) between the complete image data (I-frame).</p> <p>In CBR mode, to keep the constant bandwidth, the quality of next I-frame is degraded, when size of P-frame is increase.</p> <p>During this period, the quality will be extremely reduced.</p> <p>In CVBR mode, keep the next I-frame quality, even if the size of P-frame is increase. As a result, the bit rate increases, but the image quality improves.</p>

The default setting is "CBR".

H.264 Bitrate

H.264 Main Select the upper limit Bitrate of streaming from the following.

Table 17. Selectable items of H.264 Bitrate

H.264 Bitrate
20 Mbit
19 Mbit
18 Mbit
17 Mbit
16 Mbit
15 Mbit
14 Mbit
13 Mbit
12 Mbit
11 Mbit
10 Mbit
9 Mbit
8 Mbit
7 Mbit
6 Mbit
5 Mbit
4 Mbit
3 Mbit
2 Mbit
1 Mbit
512 Kbit
256 Kbit
128 Kbit

The higher the setting, the higher the quality, but the larger the data size is.
The default setting is “10Mbit”.

H.264 Sub

H.264 Sub Profiles

H.264 Sub Select compression profile for streaming.

Details are the same as H.264 Profiles of H.264 Main.

The default setting is "Baseline".

H.264 Sub Resolution

H.264 Sub Selects the resolution size of the streaming.

Table 18. Selectable items of H.264 Sub Resolution

H.264 Sub Resolution
640x360
320x240

The default setting is "640x360".

H.264 Sub Quality

It is enable when the Bitrate Control described later is "VBR".

Details are the same as H.264 Quality of H.264 Main.

The default setting is "50".

H.264 Sub GOP (IDR)

H.264 Sub Set compression GOP for streaming.

Details are the same as H.264 GOP of H.264 Main.

The default setting is "30".

H.264 Sub FPS

H.264 Sub Set framerate for streaming.

Details are the same as H.264 FPS of H.264 Main.

The default setting is "30fps" or "25fps".

Bitrate Control

H.264 Sub Select compression method for streaming.

Details are the same as Bitrate Control of H.264 Main.

The default setting is "CBR".

H.264 Sub Bitrate

H.264 Sub Select the upper limit Bitrate of streaming.

Details are the same as H.264 Bitrate of H.264 Main.

The default setting is "2Mbit".

MJPEG

M-JPEG Resolution

The resolution size of MJPEG streaming is fixed "1920 x 1080".

M-JPEG Quality

It is enable when the Bitrate Control described later is "VBR".

Set compression quality.

It can be set between 0 ~ 99.

The smaller the value, the lower the quality, and the larger the value, the higher the quality.

The default setting is "50".

M-JPEG FPS

MJPEG Set framerate for streaming.

Details are the same as H.264 FPS of H.264 Main.

The default setting is "30fps" or "25fps".

Bitrate Control

MJPEG Select the compression quality specification method for streaming from the following 2 method.

Table 19. Selectable items of Bitrate Control

1	VBR	Variable Bitrate. Quality is constant, and bitrate is variable.
2	CBR	Constant Bitrate. Bitrate is constant, and quality is variable.

The default setting is "CBR".

M-JPEG Bitrate

MJPEG Select the upper limit Bitrate of streaming from the following.

Table 20. Selectable items of M-JPEG Bitrate

MJPG Bitrate
50 Mbit
45 Mbit
40 Mbit
35 Mbit
30 Mbit
25 Mbit
20 Mbit
19 Mbit
18 Mbit
17 Mbit
16 Mbit
15 Mbit
14 Mbit
13 Mbit
12 Mbit
11 Mbit
10 Mbit
9 Mbit
8 Mbit
7 Mbit
6 Mbit
5 Mbit
4 Mbit
3 Mbit
2 Mbit
1 Mbit

The higher the setting, the higher the quality, but the larger the data size is.

The default setting is "20Mbit".

To update the setting value, please click "submit".

6.4.2. H.264 View

Click “H.264 View” on menu to go to the view page.

Here you can watch streaming of H.264 Main.

Streaming can be confirmed only with IE.

The first display is 1920 x 1080 size.

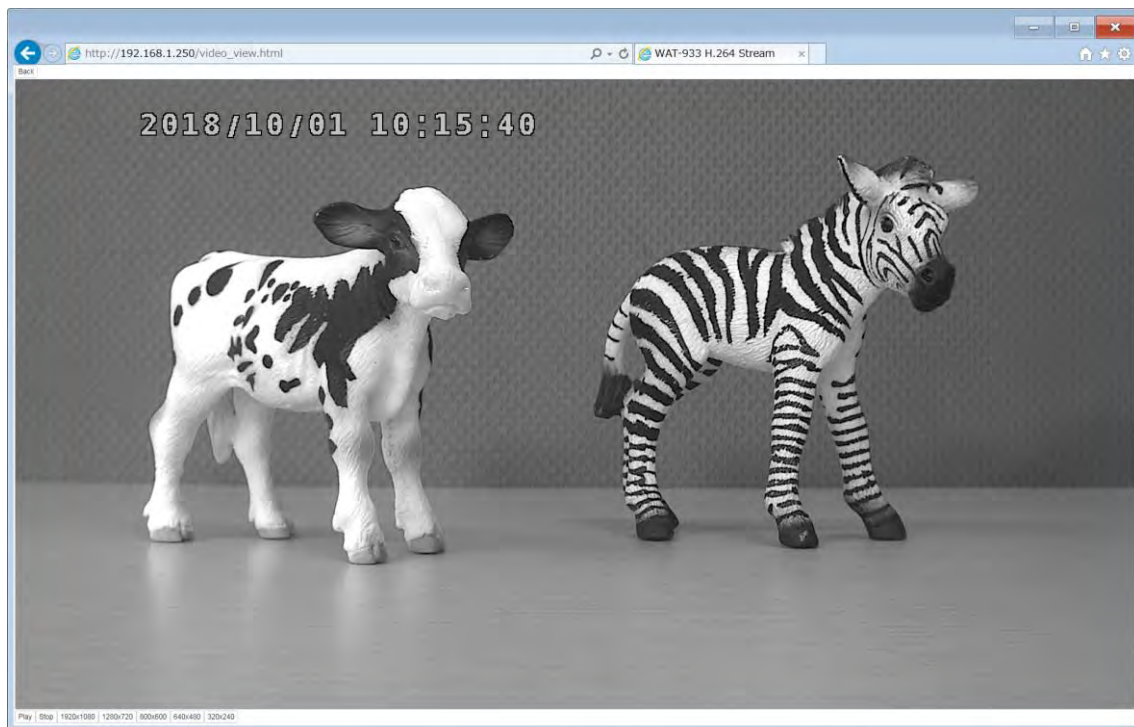

Figure 29. The H.264 view page

Back

Return the page to the previous page.

It is the same movement as the browser's back button.

Play

Start streaming.

If it has already started, pause it.

Stop

Stop streaming.

1920x1080

Change the streaming playback area to 1920 x 1080.

1280x720

Change the streaming playback area to 1280x720.

800x600

Change the streaming playback area to 800x600.

640x480

Change the streaming playback area to 640x480.

320x240

Change the streaming playback area to 320x240.

6.4.3. JPEG View

Click “JPEG View” on menu to go to the view page.

Here you can watch image of JPEG.

JPEG images are updated approximately every 3 seconds.

The image size will be fixed at 1920 x 1080.

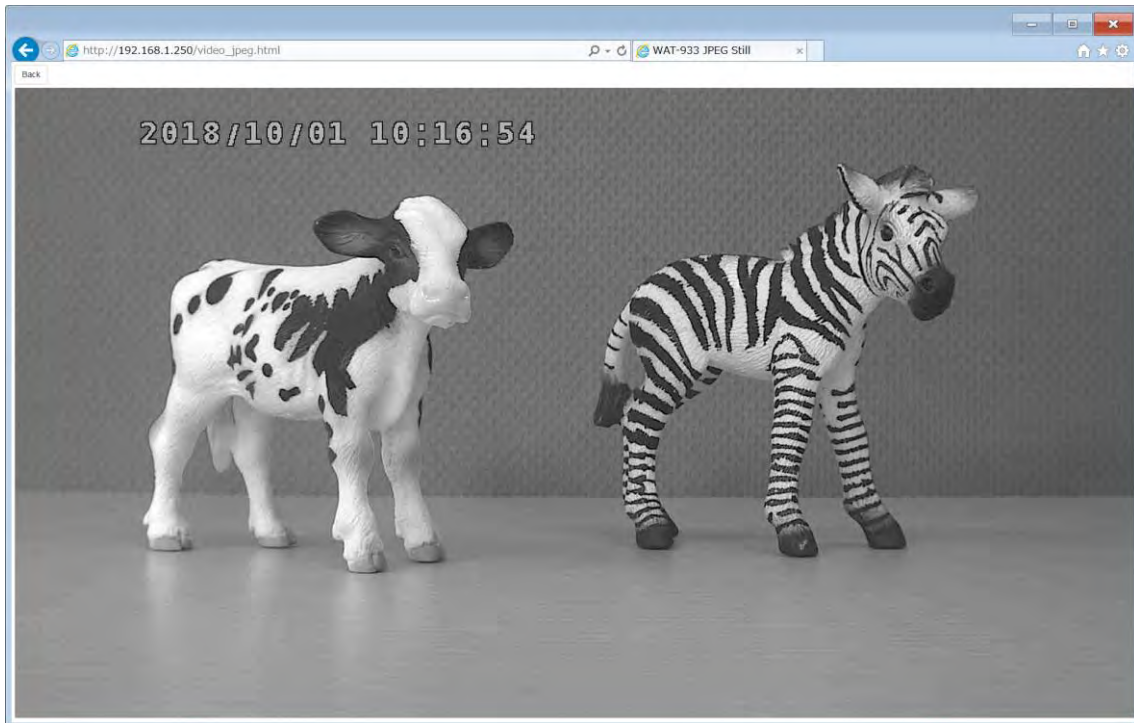

Figure 30. The JPEG view page

Back

Return the page to the previous page.

It is the same movement as the browser's back button.

6.5. NETWORK SETUP

6.5.1. Ethernet

Click “Ethernet” on menu to go to the Network Information page.

Here you can set network etc.

Network Information		submit
IP Address	<input type="text" value="192.168.1.250"/>	
Subnet Mask	<input type="text" value="255.255.255.0"/>	
Default Gateway	<input type="text" value="192.168.1.1"/>	
Primary DNS Server	<input type="text" value="8.8.8.8"/>	
Secondary DNS Server	<input type="text" value="8.8.4.4"/>	
Use DHCP Server	<input type="radio"/> USE <input checked="" type="radio"/> UNUSE	
FTP Server	<input type="radio"/> ON <input checked="" type="radio"/> OFF	

Figure 31. The Network Information page

IP Address

It is enable when the Use DHCP Server described later is “UNUSE”.

Set the IP address.

The default setting is “192.168.1.250”.

Subnet Mask

It is enable when the Use DHCP Server described later is “UNUSE”.

Set the sub-net mask.

The default setting is “255.255.255. 0”.

Default Gateway

It is enable when the Use DHCP Server described later is “UNUSE”.

Set the default gateway.

The default setting is “192.168.1.1”.

Primary DNS Server

It is enable when the Use DHCP Server described later is "UNUSE".

Configure the primary DNS server.

The default setting is "8.8.8.8".

Secondary DNS Server

It is enable when the Use DHCP Server described later is "UNUSE".

Configure the secondary DNS server.

The default setting is "8.8.4.4".

Use DHCP Server

Switch ON / OFF use of DHCP server.

When this setting is ON, this camera will receive the IP address from the external DHCP server.

The default setting is "OFF".

FTP Server

Switch ON / OFF FTP server function.

The default setting is "OFF".

For details on how to connect the FTP server, refer to "5.2. FTP Access" below.

To update the setting value, please click "submit".

6.6. SD CARD SETUP

6.6.1. Info

Click “Info” on menu to go to the SD Card Information page.

Here you can make settings related to the microSD card.

SD Card Information		submit
Total Size	61099MB	
Used Size	131MB	
Free Size	60967MB	
Free Percentage	99%	
Continuous Recording	<input checked="" type="radio"/> ON <input type="radio"/> OFF	
Save Jpeg in SD-Card		submit
Format		Format
Video & Snapshot Files		Files

Figure 32. The SD Card Information page

Total Size

Displays the total size of the microSD card.

Used Size

Displays the used size of the microSD card.

Free Size

Display the free size of the microSD card.

Free Percentage

Displays the Percentage of (Free size) / (total size).

Continuous Recording

Switch ON / OFF recording to the microSD card.

The default setting is “ON”.

Save Jpeg in SD-Card

Save JPEG still images to the microSD card.

The still image is saved at the moment when you click the “submit” button.

Format

Format the microSD card.

When you click the “Format” button, the page switches and Format starts.

When Format ends, you are prompted to restart, click the “OK” button.

Please attention that saved data on the microSD card will be deleted.

Video & Snapshot Files

Download recorded video and still images saved to the microSD card.

In order to use this function, you need to set Continuous Recording to “OFF”.

When you click the “Files” button, you can check the file to the microSD card.

To update the setting value, please click “submit”.

6.6.2. Schedule

Click “Schedule” on the menu to go to the Record Schedule page.

Here you can make settings related to the Record Schedule.

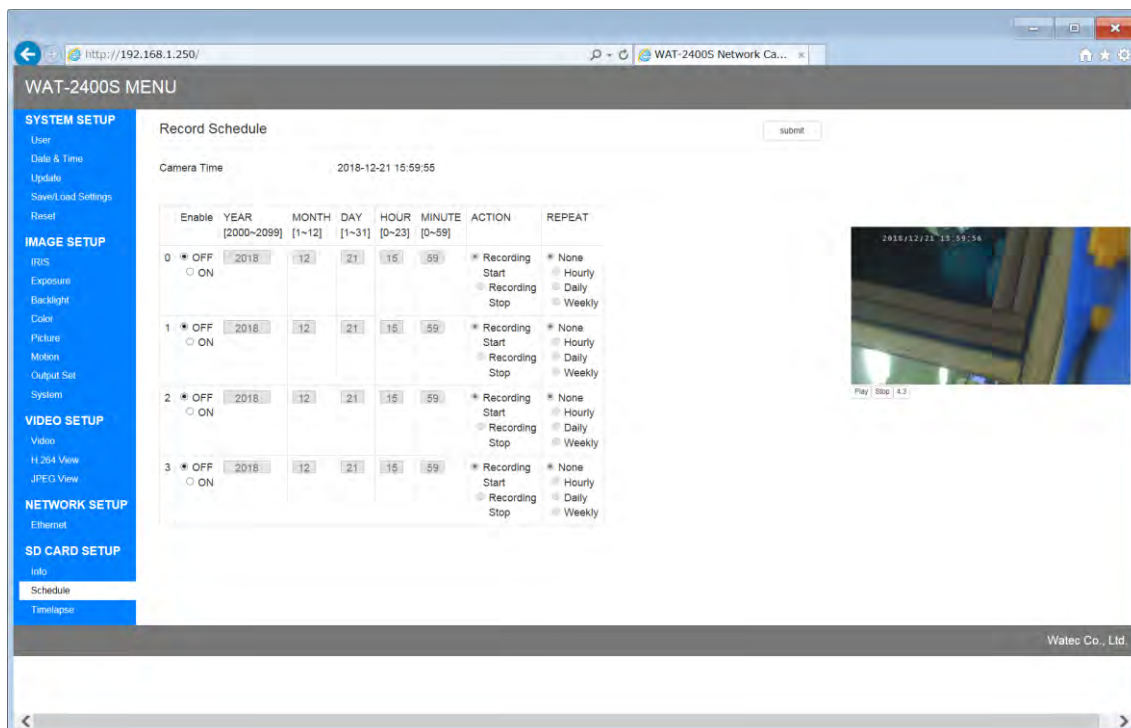

Figure 33. The Record Schedule page

Camera Time

Display the current time of the camera.

Schedule

A total of 4 schedules can be set.

The “Enable” is all OFF by default settings.

When the “Enable” is OFF, the current time is automatically set.

The setting items of each mask are explained below.

A) Enable

Switch Enable ON / OFF of the Schedule.

- B) YEAR
Set a year of schedule.
It can be set between 2000 ~ 2099.
- C) MONTH
Set a month of schedule.
It can be set between 1 ~ 12.
- D) DAY
Set a day of schedule.
It can be set between 1 ~ 31.
- E) HOUR
Set an hour of schedule.
It can be set between 0 ~ 23.
- F) MINUTE
Set a minute of schedule.
It can be set between 0 ~ 59.
- G) ACTION
Decide the operation at the schedule execution.
It can be selected from Recording Start/ Recording Stop".
The default setting is the "Recording Start".
If the schedule execution time of the "Record start" arrives when the recording is already in progress, it will not do anything.
- H) REPEAT
Decide whether to repeat the schedule after schedule execution.
It can be selected from None/Hourly/Daily/Weekly.
The default setting is "None".
After the schedule execution, when the setting is other than None, it will be automatically updated to the next execution time.

To update the setting value, please click "submit".

6.6.3. Timelapse

Click “Timelapse” on the menu to go to the Timelapse page.

Here you can make settings related to the Timelapse.



Figure 34. The Timelapse page

Camera Time

Display the current time of the camera.

Timelapse Enable

Switch ON / OFF Timelapse function.

The default setting is “OFF”.

Image saving starts when it is set to ON, and image saving is performed each time the Interval Time elapses.

Interval Time

Set the image save interval.

It can be set between 10 ~ 604800 sec.

The default setting is "10".

To update the setting value, please click "submit".

6.7. How to initialize the camera setting

You can use the microSD card to initialize the settings.

This initialization method can be used, for example, when you forget the ID / password required to login to the web setting page.

If you can login to the WEB setting page, initialization is possible with "4.2.5.Reset".

The procedure is described below.

- I. Mount the microSD card to be used to the PC.
- II. Format microSD card in Fat32.
- III. Create a file named "all_reset.bin" just under the drive of the microSD card.
Note: Please make it as a text file and make the file size 0 Byte.
All file names should be in lower case.
- IV. Unmount & Remove the microSD card from the PC.
- V. Power off this camera.
- VI. Mount the microSD card to this camera.
- VII. Power on this camera.
- VIII. Please wait for a while until it starts up. It will start in about 30 seconds.
- IX. When this camera is initialized correctly, "all_reset.bin" of the microSD card will be deleted. If initialization is not done, remount the microSD card to the PC and confirm that "all_reset.bin" has been deleted.
If "all_reset.bin" has not been deleted, please check the file name and file size again.

7. Reference

7.1. How to use ONVIF Device Manager

This camera conforms to the ONVIF Profile S.

Download the ONVIF Device Manager (ODM) from the following link;

<http://sourceforge.net/projects/onvifdm/>

Then install the ODM to your PC and initiate the ODM.



ODM starts as follows;

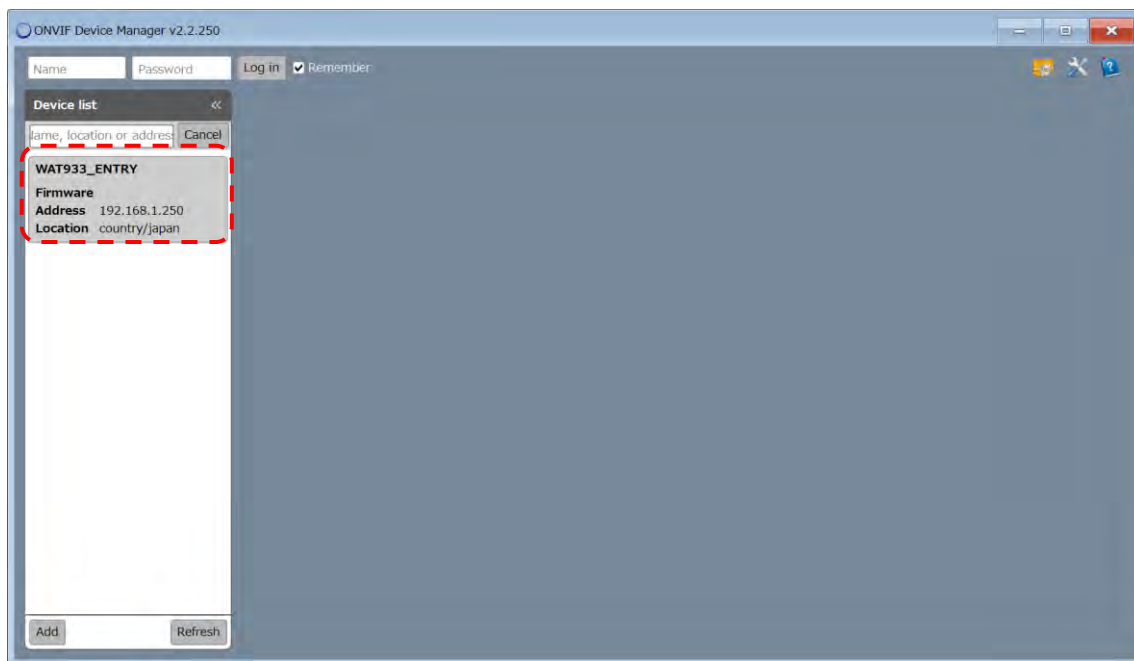

Figure 35. ODM screen

If the network configuration has been successfully connected without error, the WAT-933_ENTRY or WAT-2400S_ENTRY will show up in the Device list. Please make sure there is no error in the network settings if you do not see.

In the text box at the top of the screen, enter the ID and Password of the above-mentioned the User Information page in Name and Password respectively, and click "Log in". When you have not changed, enter Name: root, Password: 1234.

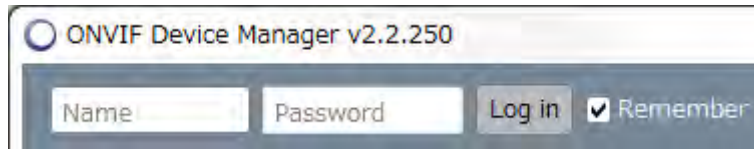

Figure 36. ODM Login

Once you have finished the login and click the "WAT-933_ENTRY" or "WAT-2400S_ENTRY" of the Device list. Since the menu is open, click "Live video". If there is not any problem, the moving image will be displayed as shown in the figure below.

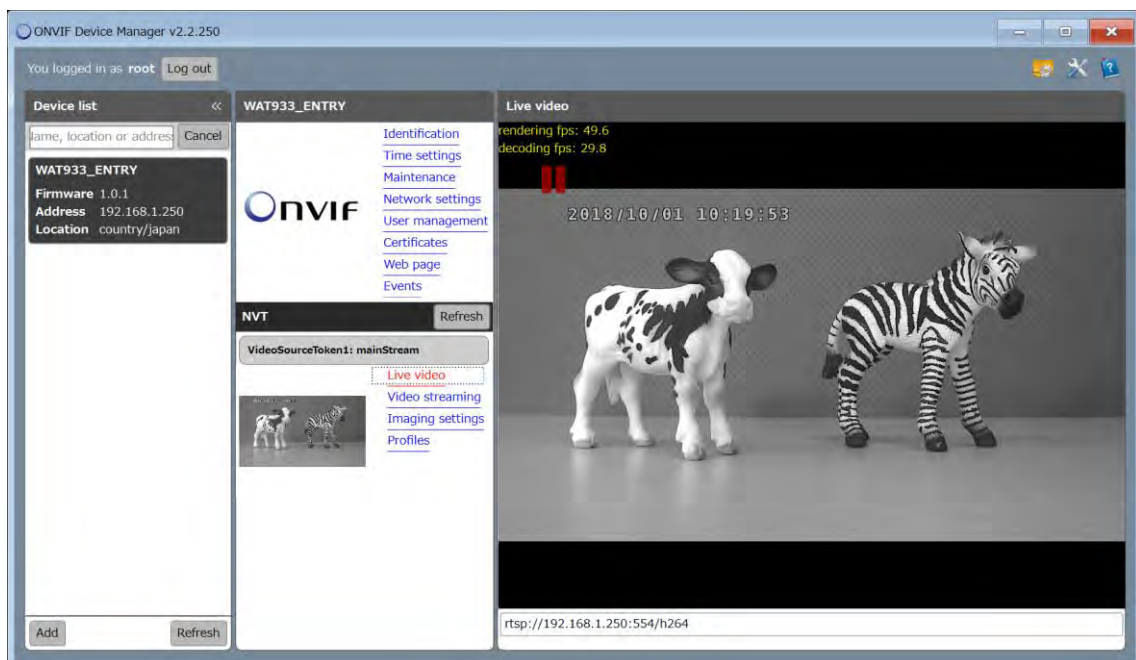

Figure 37. Live video screen

In case of such as "Loading" is displayed and the image does not appear, please restart the ODM.

7.2. FTP Access

You can access internal storage by using FTP.

This section explains the connection method of using "FileZilla".

7.2.1. A case of FileZilla

Download the appropriate Installer which meets your PC from FileZilla official download page (<https://filezilla-project.org/>) and install it.



Open the FileZilla when the installation is completed.

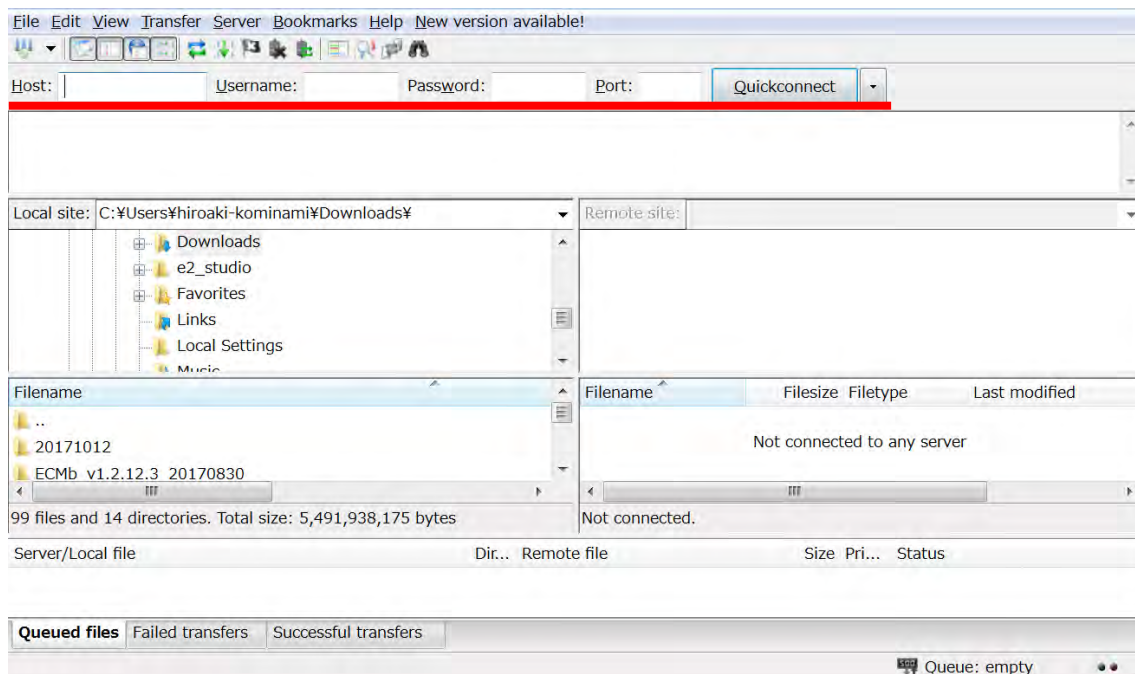

Figure 38. FileZilla screen

When this camera is the default setting, enter the following in the red line above.

Host: 192.168.1.250

Username: root

Password: 1234

Port: (Blank)

Click "Quickconnect" to access internal storage.

7.3. When streaming does not play on WEB setting page

Please check the following items.

7.3.1. Checking the web browser you are using

Internet Explorer 11 (simply called the “IE11” from now.) only supports streaming on the web setting page.

In order to display streaming of the IE 11, please make the following settings.

7.3.2. Setting the IE

I. **Start the IE11**

II. **Click “Tools”->”Internet options”->”Advanced”->”Reset”**

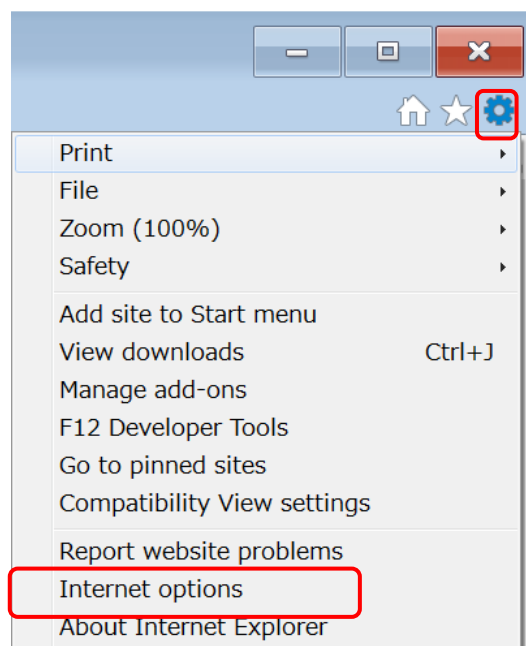

Figure 39. How to set the IE 11 (No.1)

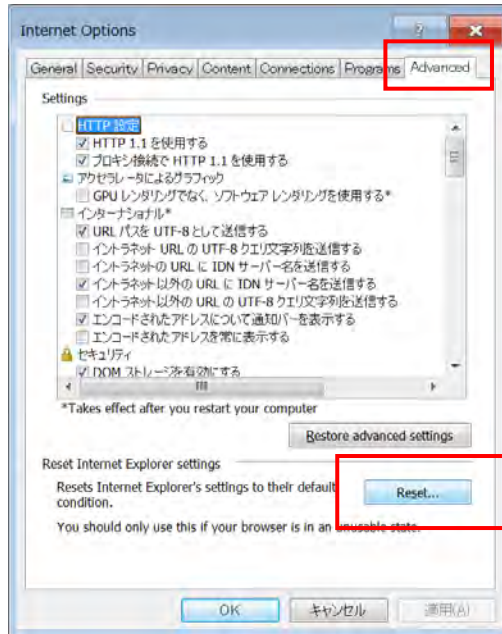

Figure 40. How to set the IE 11 (No.2)

III. Click “Reset”

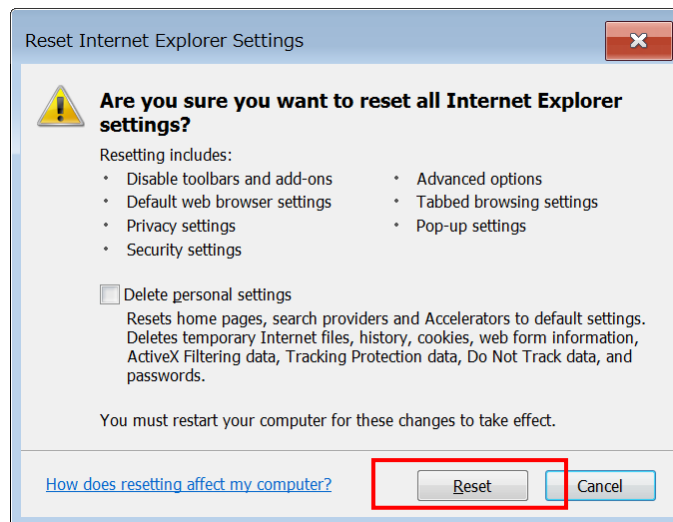

Figure 41. How to set the IE 11 (No.3)

IV. Restart the IE11

V. Click “Tools”->”Internet options”->”Security”

VI. Select “Internet”->”Medium”

VII. Click “OK”

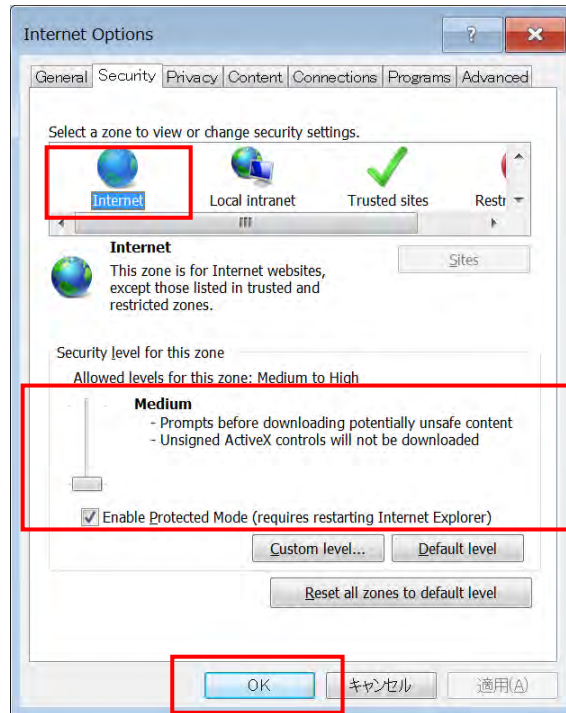

Figure 42. How to set the IE 11 (No.4)

VIII. Uncheck “Tools”->”Safety”->“ActiveX Filtering”

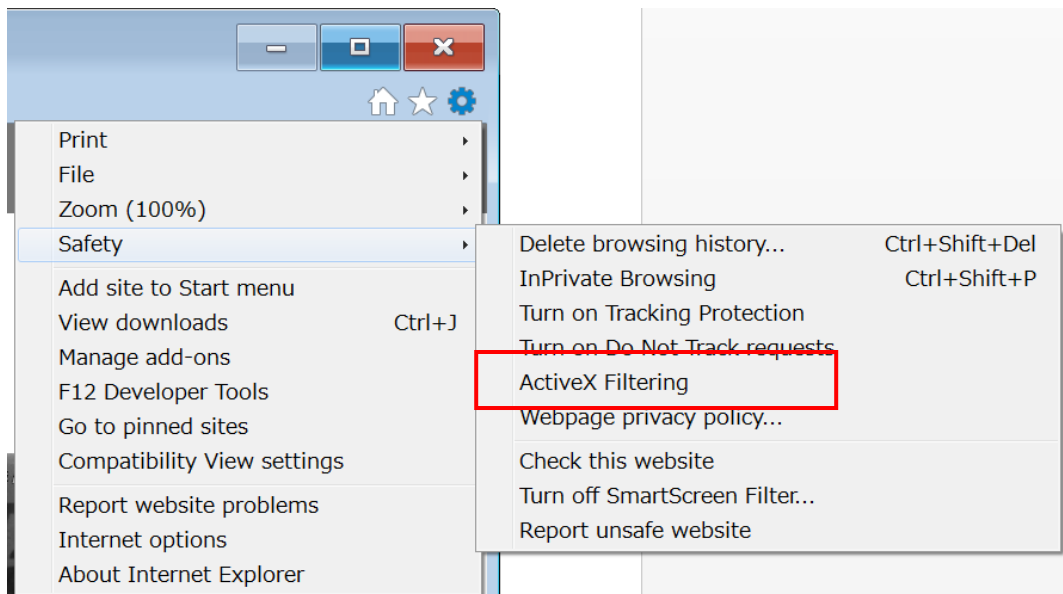

Figure 43. How to set the IE 11 (No.5)

IX. Restart the IE11, Access the setting page

7.3.3. Reinstall the VLC

Note: If the streaming was not successful with “2. Setting the IE”, please follow the procedure in “3. Reinstall the VLC”.

I. Uninstall the VLC

When the 64bit OS, uninstall the VLC for 32bit and 64bit

II. Install the VLC

When the 32bit OS, install the VLC for only 32bit.

When the 64bit OS, install the VLC for 32bit and 64bit.

32bit VLC: <https://get.videolan.org/vlc/3.0.3/win32/vlc-3.0.3-win32.exe>

64bit VLC: <https://get.videolan.org/vlc/3.0.3/win64/vlc-3.0.3-win64.exe>

When the following window is displayed halfway, select "Full" or check "ActiveX plugin".

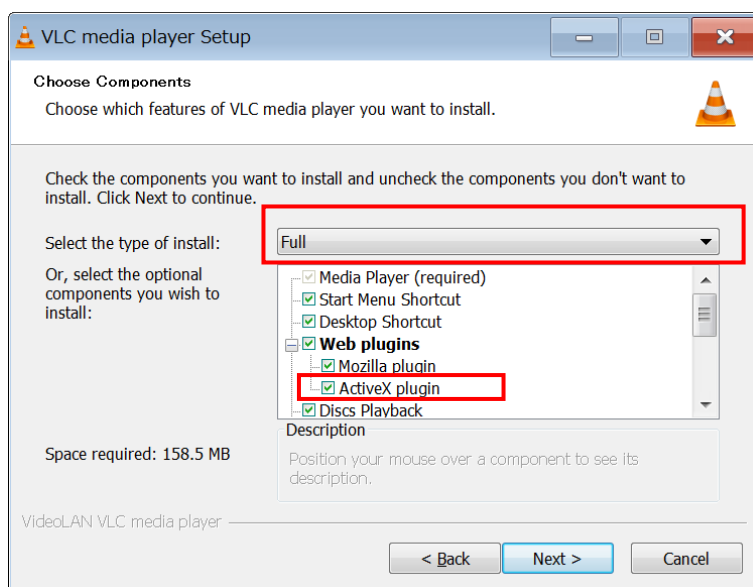

Figure 44. Installation of the VLC

III. Restart the IE11, Access the setting page

7.3.4. Disable Anti-Virus

Note: If streaming was not successful with “3. Reinstall the VLC”, please follow the procedure in “4. Disable Anti-Virus”.

Please note that Watec is not responsible for any damage or loss caused through disable Anti-virus.

- I. **Disable Anti-Virus**

- II. **Restart the IE11, Access the setting page**